

Article number: 09065525

Description: KLEE Feather keys B 5x5x25 DIN 6885

Measures

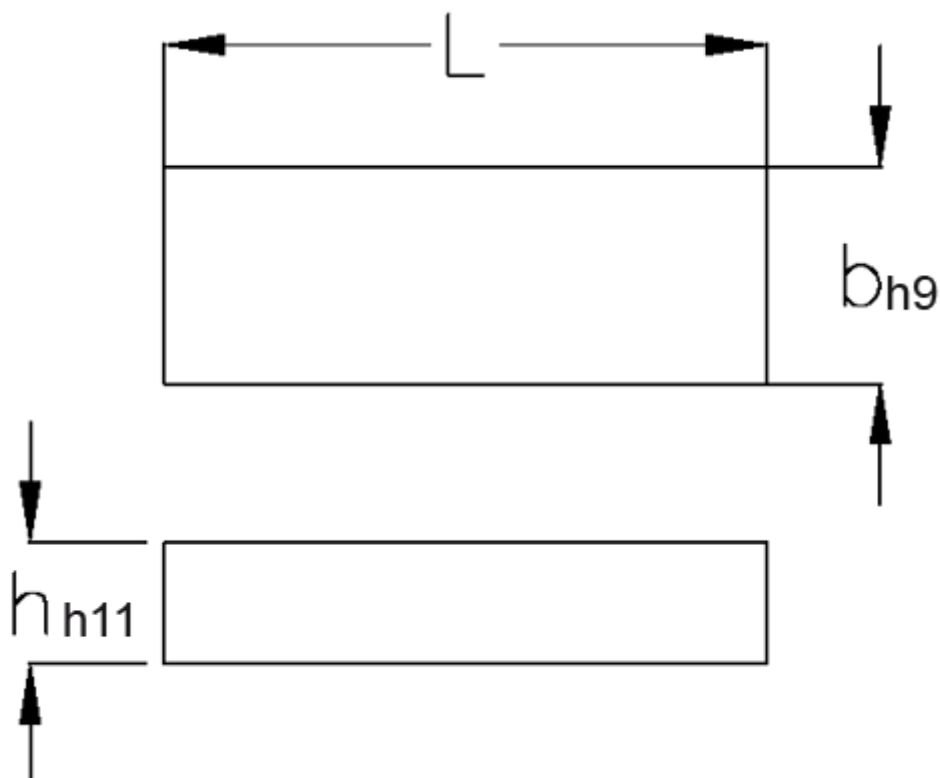

b	$= 5$
h	$= 5$
L	$= 25$
Tolerance b	$= 0.030$
Tolerance h	$= 0.075$
Tolerance L	$= -0,3$